

SIM Card Data

Subscriber number: _____

PIN Code * (4 to 8 digits): _____

Unblocking Code (8 digits): _____

Barring Password * (4 digits): _____

* Changeable

Press out and keep in a secure place

Telephone Data

Serial number: _____

Unlock Code * (3 or 4 digits): _____



Security Code ** (6 digits): _____

* Changeable, upon delivery = 1 2 3







** Changeable, upon delivery = 0 0 0 0 0 0

Press out and keep in a secure place

To Turn On

1. Insert SIM Card.
2. Turn on:  
3. If prompted:  PIN Code  & Unlock Code 

To Make a Call

1. Check  is off.
2.  Telephone number (No dial tone).
3.   or lift the handset.
4. To end the call: Replace the handset or  

Quick User Guide

To Answer a Call

Lift the handset. To end the call: Replace the handset.

To Recall a Short-number

By short-number:  **MR** Short-number

By name:  **MR**  **a**
c First letter

Emergency Call

 **1** **A**
B
C **1** **A**
B
C **2** **D**
E
F  then lift the handset

Inform operator about your subscriber number, position and the type of emergency. Stay by the telephone.

Quick User Guide

SAFETY

IMPORTANT READ THIS INFORMATION BEFORE USING YOUR TRANSPORTABLE CELLULAR TELEPHONE

The cellular telephone is one of the most exciting and innovative electronic products ever developed. With it you can stay in contact with your office, your home, emergency services, and others.

General

For the safe and efficient operation of your phone, observe these guidelines.

Your transportable cellular telephone is a radio transmitter and receiver. When the phone is ON, it sends out and receives radio frequency (RF) energy. The phone operates in the GSM frequency range of 890MHz to 960MHz (or DCS 1800 frequency range of 1710MHz and 1880MHz) and employs commonly used Time Division Multiple Access (TDMA) digital modulation techniques. When you use your phone, the cellular system handling your call controls the power level at which your phone transmits. The pulsed power level can range from 0.02 of a watt to 8 watts.

SAFETY

Exposure to Radio Frequency Energy

Research on health effects from RF energy has focused for many years on FM radio technology. That research and studies regarding newer radio technologies, such as TDMA, have found no credible scientific evidence that adverse health effects result from the use of a portable cellular telephone.

In 1991 the Institute of Electrical and Electronic Engineers (IEEE), and 1992 the American National Standards Institute (ANSI) adopted the 1982 ANSI Standard for safety levels with respect to human exposure to RF energy.

Over 120 scientists, engineers, and physicians from universities, government health agencies, and industry, after reviewing the available body of research, developed this updated Standard. In March, 1993 the Federal Communications Commission (FCC) of N. America proposed the adoption of this updated Standard. To operate within this updated ANSI standard, use your phone as described under "Efficient Phone Operation".

Efficient Phone Operation

Do not operate your transportable cellular telephone when holding the antenna, or when any person is within 10 centimetres (4 inches) of the antenna.

SAFETY

Of course, if you want to limit RF exposure even further than the updated ANSI Standard, you may choose to control the duration of your calls or maintain a distance from the antenna of more than 10 centimetres (4 inches).

For best call quality, keep the antenna free from obstructions and point it straight up.

Antenna Care and Replacement

Do not use the phone with a damaged antenna. If a damaged antenna comes into contact with the skin, a minor burn may result. Replace a damaged antenna immediately. Consult your manual to see if you may change the antenna yourself. If so, use only a manufacturer-approved antenna. Otherwise, have your antenna repaired by a qualified technician.

Use only the supplied or approved antenna. Unauthorised antennas, modifications or attachments could damage the phone and may contravene local RF emission regulations or type approval.

Driving

Check the laws and regulations on the use of cellular telephones in the areas where you drive. Always obey them. Also, when using your phone while driving, please:

- give full attention to driving,

SAFETY

- use hands-free operation, if available, and
- pull off the road and park before making or answering a call if driving conditions so require.

Electronic Devices

Most electronic equipment, for example in hospitals and motor vehicles is shielded from RF energy. However, RF energy may effect some malfunctioning or improperly shielded electronic equipment.

Vehicle Electronic Equipment

Check with your vehicle manufacturer's representative to determine if any on board electronic equipment is adequately shielded from RF energy.

Medical Electronic Equipment

Consult the manufacturer of any personal medical devices (such as pacemakers, hearing aids, etc) to determine if they are adequately shielded from external RF energy.

Turn your phone **OFF** in health care facilities when any regulations posted in the area instruct you to do so. Hospitals or health care facilities may be using RF monitoring equipment.

SAFETY

Aircraft

Turn your phone **OFF** before boarding any aircraft.

- Use it on the ground only with crew permission.
- Do not use in the air.

To prevent possible interference with aircraft systems, Federal Aviation Administration (FAA) regulations require you to have permission from a crew member to use your phone while the plane is on the ground. To prevent interference with cellular systems, local RF regulations prohibit using your phone whilst airborne.

Children

Do not allow children to play with your phone. It is not a toy. Children could hurt themselves or others (by poking themselves or others in the eye with the antenna, for example). Children could damage the phone, or make calls that increase your telephone bills.

Blasting Areas

To avoid interfering with blasting operations, turn your unit **OFF** when in a "blasting area" or in areas posted: "turn off two-way radio". Construction crews often use remote control RF devices to set off explosives.

SAFETY

Potentially Explosive Atmospheres

Turn your phone **OFF** when in any area with a potentially explosive atmosphere. It is rare, but your phone or its accessories could generate sparks. Sparks in such areas could cause an explosion or fire resulting in bodily injury or even death.

Areas with a potentially explosive atmosphere are often, but not always, clearly marked. They include fuelling areas such as petrol stations; below decks on boats; fuel or chemical transfer or storage facilities; and areas where the air contains chemicals or particles, such as grain, dust, or metal powders.

Do not transport or store flammable gas, liquid, or explosives, in the compartment of your vehicle which contains your phone or accessories.

Before using your phone in a vehicle powered by liquefied petroleum gas (such as propane or butane) ensure that the vehicle complies with the relevant fire and safety regulations of the country in which the vehicle is to be used.

SAFETY

This Cellular Telephone complies with all applicable RF safety standards.

This cellular telephone meets the standards and recommendations for the protection of public exposure to RF electromagnetic energy established by governmental bodies and other qualified organisations, such as the following:

- **Verband Deutscher Elektroingenieure (VDE) DIN-0848**
- **Directives of the European Community, Directorate General V in Matters of Radio Frequency Electromagnetic Energy**
- **National Radiological Protection Board of the United Kingdom. GS-11, 1988.**
- **American National Standards Institute (ANSI)/IEEE. C95. 1-1992**
- **National Council on Radiation Protection and Measurements (NCRP). Report 86**
- **Department of Health and Welfare Canada, Safety Code 6.**

SAFETY

MANUAL UPDATES

There are no manual updates at this time

MANUAL UPDATES

CONTENTS

ESSENTIAL INFORMATION

1

INTRODUCTION	7
DISPLAY, INDICATORS AND KEYPAD	7
Display	7
Indicators	7
Volume Control	9
Keypad	10
BASIC OPERATION	12
About the SIM Card	12
Inserting the SIM Card	12
On/Off	13
Entering the PIN Code	14
Electronic Lock	15
Automatic Lock	16
Placing a Call	16
Receiving a Call	16
Call in Absence	17
ADVANCED CALL PLACEMENTS	17
Handsfree Calls	17
Automatic Answer	18
Automatic Redial	18
International Calls	19
Emergency Calls	19
SHORT-NUMBERS	20
Short-number Programming	21
Entering a Name	21
Entering the Short-number	21
Programming Examples	22
Short-number Recalling/Dialling	24
Speed Dialling	25
Short-number Clearing	25
Reviewing Phone Numbers	26

CONTENTS

ADVANCED INFORMATION

2

MEMORY FEATURES	27
Notepad	27
Last Number Dialed	27
SYSTEM REGISTRATION	28
Automatic Roaming	28
Manual Roaming	29
Preferred Network Operator List	30
Displaying the Preferred List	30
Changing the Preferred List	30
MENU OPERATION	31
Status Review	34
Master Reset	35
Master Clear	36
INTERFACE FEATURES	36
Ringer ON/OFF	36
Keypad Tones ON/OFF	37
Tone Signalling Features	37
Notepad Tones ON/OFF	37
Memory Linking	38
Pauses in Memory	38
DTMF Signalling	39
Long Tone DTMF	40
PIN Code Enable/Disable	40
Language Selection	41
Safety Timer	41
Entertainment Mute	42
Auxiliary Alert	42

ADVANCED INFORMATION**2**

Adjust Light Level	43
CALL MONITORING	43
One Minute Audible Call Timer	44
Programmable Audible Call Timer	44
Visual Call Timers and Meters	45
To Display Call Timers	46
To Display Call Meters	47
Programming of Rates	47
Automatic Monitor Displays	48
CALL RESTRICTIONS	48
Restricted Keypad Dialling	49
Restricted Memory Access	49
Restricted Incoming Calls	50
Restricted Phone Number Length	50
Full Service	51
CALL BARRING	51
Activating Call Barring	52
Cancelling Call Barring	53
Status of Call Barring	53
Changing Call Barring Password	54
Special Call Barring Messages	54
CALL FORWARDING	55
Activating Call Forwarding	56
Cancelling Call Forwarding	56
Status of Call Forwarding	57
Special Call Forwarding Messages	58
CHANGING THE UNLOCK CODE	58
CHANGING THE SECURITY CODE	59
CHANGING THE PIN CODE	59
UNBLOCKING THE SIM CARD	60

CONTENTS

ADVANCED INFORMATION

2

SHORT MESSAGE SERVICE (SMS)	62
Automatic Cell Broadcast	62
Point to Point Short Messages	64
Receiving Point to Point Messages	64
Storage of Point to Point Messages	65
Reading Point to Point Messages	65
Clearing Messages From Memory	66
Embedded Callback Numbers	67
Short Message Alert Tone	67
CALL WAITING AND CALL HOLDING	68
Call Waiting	68
Call Holding	69
Call Hold and Waiting Combinations	69
Call Hold and Making New calls	72
Call Hold and Call Waiting Messages ...	72
Emergency Calls and Call Hold/Wait	73

ACCESSORIES AND OPTIONS

3

CARRYING CASSETTE 75
 Overview 75
 Removal from the Vehicle 75
 Insertion into the carrying cassette 76
 To Insert the Battery 76
 To Remove the Battery 76
 Battery Charging 76
 Overnight Charger 77
 Spare Battery Charger 77
 Cigarette Lighter Adaptor 77
 Mains Operation - Rapid Charging 77
 Operation in the Carrying Cassette 78
 Keypad and Display Lighting 78
 Hands Free Operation 78
 Low Battery Indicator 78
 Battery Saving Feature (DTX) 79
 Use Inside a Vehicle 79

REMOTE CARD READER 80

INDEX 81

CONTENTS

INTRODUCTION

This cellular telephone is designed for the Pan-European GSM System. Using this telephone makes it possible to contact any telephone in the world, provided you are in an area covered by the GSM system.

The cellular telephone does not contain your GSM-subscriber number, this information is contained on your SIM card supplied by your local network operator. All billing will be registered, when the conversation takes place, to the subscriber number on the SIM card which is inserted in the telephone.

DISPLAY, INDICATORS AND KEYPAD







See flap at the front cover.

Display

1. The 20-character display is used to show telephone numbers, short-numbers and messages which inform you of the operation of the telephone. When the display is not in use for other purposes, it will show the country code and the identity of the network operator.

Indicators

2. ▲ Roam
Steady symbol: You are registered on a preferred system different from your home system.
Flashing symbol: You are registered on a non-preferred system.

3.  In Use
Indicator appears whenever a call is in progress.
4.  Power On
Indicator appears when the telephone is on.
5.  No Service
Steady symbol: Indicates that the telephone is outside any system coverage.
Flashing symbol: Indicates that the telephone is in an area with coverage, but is not registered with the system. You are able to place emergency calls using the special GSM emergency number 112, but you are unable to place/receive ordinary calls.
6.  Short Message
This icon is used to support various SMS features.
7.   Signal Strength
The more segments displayed in the bar graph, the better the signal strength and call quality. When the phone is not in service, only one segment of the bar graph is lit.
8.  Battery Level (Transportable only)
Fixed symbol: Battery charge level is sufficient for normal operation.
Slow Flash: Warning! Battery charge level is becoming low.
Rapid Flash: Battery charge level is nearly depleted. Replace or recharge battery.

Cold Temperature Note

This phone is equipped with the latest in display technology. This "supertwist" liquid crystal display (LCD) provides superior performance, viewing angle and viewing contrast over previous LCD technologies. At extremely cold temperatures, it is normal for the display to respond more slowly to key presses. *When entering numbers under these circumstances, the audible tones will still indicate that a key has been depressed and the visual indication will follow shortly.*

Volume Control

9. Volume

The volume buttons on the side of the handset adjust the earpiece, ringer and speaker volume levels. Press the top button to increase, or the bottom button to decrease, the volume level.



To adjust speaker volume:

Operate the volume buttons when the handset is in the hang-up cup.

To adjust earpiece volume:

Operate the volume buttons with the handset out of the hang up cup.

To adjust ringer volume:

  and operate the volume buttons.

1









ESSENTIAL INFORMATION













Keypad

The keypad and the display are back lit whenever the ignition is switched on. If the ignition is turned off, the unit will work as it does when it is in the carrying cassette. See the section "Carrying Cassette" for details. The number key portion of the keypad (12 keys) is used for telephone number and letter entries.

The function key portion of the keypad, with universal symbols (9 keys) is used to enable specific functions.

The following paragraphs describe the major uses of these keys

10.  Scroll Backward in memory / menus.
11.  Scroll Forward in memory / menus.
12.  Memory Recall
Press  and hold to recall last number entered.
Press  followed by the short number you want to recall from memory.
13.  Store
Used when storing telephone numbers into the memory and to confirm choices in menus.
14.  On-Off
The  indicator appears when the telephone is on.

15.  Menu/SMS
Menu
Initiates selection of features in the menus.
Selected by pressing  .
- Short Message Service (SMS)*
This icon is used to support various SMS features.
16.  Letter entry / Clear
Letter entry:
Letter entry is used when programming and recalling names with short-numbers.
Enabled by pressing  .
- Clear:*
Short press on  clears last digit.
Long press on  clears entire display.
17.  Send
Initiates call to the entered number.
Answers incoming calls.
18.  End
Terminates calls.
19.  Secondary functions.
Initiates the following functions:
Menu, letter entry, adjustment of ringer volume and adding of international prefix.
20.  Mute
Switches the microphone off/on during conversation.

1

ESSENTIAL INFORMATION

BASIC OPERATION

About the SIM Card

Your network operator has provided you with a subscription card generally known as a **Subscriber Identity Module Card** or SIM Card. The SIM Card is your personal key to accessing GSM services and contains all of your personal data including:

- subscriber number,
- home system,
- services subscribed to,
- PIN and Unblocking codes.

Your valid SIM Card must be correctly inserted into the card reader to access services.

Inserting the SIM Card

The SIM card may be inserted in the card reader located on the transceiver either before or after turning the telephone on.

If you have an optional Remote Card Reader, please refer to Section 3, "Accessories and Options".

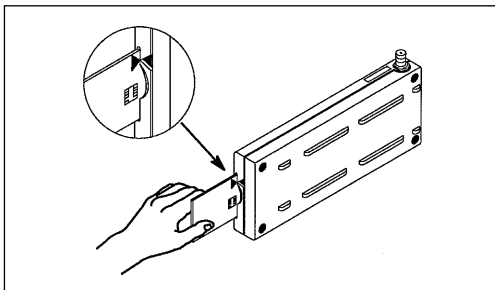

Inserting the SIM Card

If the SIM card is missing or not correctly inserted, e.g. inserted upside down or backwards, the display reads:

Action:

'Insert Card': Insert the SIM Card

'Check Card': Check for proper orientation and re-insert the SIM Card

On/Off

Switch-on:  

If the SIM card is not already inserted the display will prompt you to do so.

The telephone then checks the validity of the SIM card.

If the validation is OK, the display may show:

'Enter PIN': This indicates that the SIM Card is protected by a PIN Code. See the section, "Entering the PIN Code".

'Enter Unlock Code': This indicates that the telephone is protected by an electronic lock.

To unlock:  Unlock Code 

See the section, "Electronic Lock".

If a problem exists with the SIM Card, the display shows one of the following messages:

'Blocked': See the section, "Unlocking the SIM Card".

'Bad Card' or **'Blocked'**, then **'See Supplier'**: Please seek help from your network operator.

1

ESSENTIAL INFORMATION

Switch-off.  

After switch-off there may be a 2-3 second delay before it is possible to switch-on again.

Entering the PIN Code

PIN is an abbreviation of **Personal Identification Number**. The PIN Code is a 4 to 8 digit code which protects your SIM card from unauthorized use.

The first PIN Code is selected by the SIM card provider. It may be changed or disabled. See the sections, "Changing the PIN Code" and "PIN Code Enable/Disable". If the SIM card is protected by a PIN Code, the display shows:



'Enter PIN'

Each time the telephone is switched on or the SIM card is inserted, you must enter:

 PIN Code 

The PIN Code will be displayed as stars.

If you make a mistake while entering the

PIN Code, you may correct it by  

If the PIN Code is accepted, the display shows:

'OK'

If the PIN Code is not accepted, the display shows:

'Wrong PIN' followed by **'Enter PIN'**

and you must re-enter the PIN Code.

If you do not succeed after three attempts the display shows:

'Blocked'

and the SIM card is blocked for further use until it has been unblocked by a special unblocking procedure. See the section, "Unlocking the SIM Card".

Electronic Lock

The electronic lock protects your phone from unauthorized use. If locked, a three or four digit unlock code must be entered before the telephone can be used. If the display shows:

'Enter Unlock Code'

the telephone is protected by the electronic lock.

To unlock:  Unlock Code 

To lock:   

If you want to change the unlock code see the section, "Changing the Unlock Code".

Note: Upon delivery the unlock code is set to 123. If you forget the unlock code, the electronic lock will not prevent you from entering menu mode to access the display/change unlock code option. Your security code will be required to change the unlock code.

Ensure that you record your security code and unlock code in a safe place.

1

ESSENTIAL INFORMATION

Automatic Lock

The phone can be set to automatically lock every time the phone is turned off.

To enable/disable automatic lock:





To toggle the function on/off:



Placing a Call

When the \emptyset indicator is off, you may place a call as follows:

 Telephone no. (max. 20 digits) 

Lift handset and converse when answered.

End the conversation by:

Replacing the handset, or  

Also see the section, "Handsfree Calls".

If a call is temporarily interrupted, the display may show:

'Retrying'

The GSM system will automatically re-connect the call if possible.

Receiving a Call

When the telephone is called, the alert signal for incoming calls is heard.

If the handset is in the hang-up cup:

Answer by lifting the handset.

If the handset is not in the hang-up cup:

Answer by  

End the conversation by:

Replacing the handset or  

To stop alert signal without answering:

Also see the section, "Handsfree Calls".

Call in Absence

When a call has been received but the phone has not been answered, the message "***Call***" will be displayed. If the phone is locked the message "**Locked**" will appear after pressing the  button to clear the "***Call***" message from the display.



ADVANCED CALL PLACEMENTS

Handsfree Calls

Outgoing calls:

The handset must be in the hang-up cup.

When the  indicator is off, you may place a call as follows:

 Telephone number 

Direct conversation to the microphone.



End the conversation by:  

1

ESSENTIAL INFORMATION

Incoming calls:

The handset must be in the hang-up cup. When the telephone is called, the alert signal for incoming calls is heard. Answer by:

  or any of the 12 number keys



Direct conversation to the microphone.

End the conversation by:  

Switching from Hands Free to Handset:

- Lift handset

Switching from Handset to Hands Free:

 , place handset in hang-up cup.

Automatic Answer

This feature allows you to reply to an incoming call without pressing any keys.

How to operate:

The handset must be in the hang-up cup. When the telephone is called, the alert signal for incoming calls rings twice. The Hands Free microphone and loudspeaker are automatically switched on.

Direct conversation to the microphone.

End the conversation by:  

To enable/disable the feature:

Automatic Redial

If a call attempt is unsuccessful, you may enable an automatic redial procedure. The telephone will then initiate multiple redial attempts until the call is connected or the redial procedure times out.

How to operate:

After a failed attempt, such as subscriber busy,



Before ending the call

The display will show: **'Redial'**
as long as the automatic redial procedure is active.

To cancel the automatic redial procedure:



International Calls

Just like using the ordinary telephone system, you must add an international prefix before dialling the country prefix and the telephone number. The international prefix will automatically be added if you use this feature.

How to operate:



(display shows: +)

country prefix, telephone number



Note that it is possible to store the  sequence in the short-number memory and still have the maximum of 20 digits.

1

ESSENTIAL INFORMATION

Emergency Calls

Emergency calls may be placed in two ways.

To dial the GSM emergency number, 1 1 2,



This call may be initiated with or without a SIM card inserted and despite electronic lock activation. The call is directed to a central emergency operator if the \emptyset indicator is either flashing or off.

To dial the local emergency number of the ordinary telephone system,



The SIM card must be inserted and the \emptyset indicator switched off.

This call is completed like any ordinary call.

SHORT-NUMBERS

The telephone has storage locations (referred to as short-numbers) for 100 telephone numbers and names which can be used to quickly dial frequently called telephone numbers. Each location can hold a telephone number up to 20 digits in length and a name up to 16 characters long.





Short-numbers stored in the telephone are labelled from 1 through 100.

The SIM card may be capable of storing additional short-numbers. Your card operator will inform you of your card's capacity for storing short-numbers. SIM card short-numbers are labelled from 101 and up.

For convenient recall, you may store your own telephone number into a short-number which is easy to remember (e.g. 1 or 101).

Short-number Programming

Programming a name and number:

   Name 
 Telephone number  Short-number



Programming a number without a name:

 Telephone number  Short-number

Below you will find a more detailed explanation and examples of the short-number programming.

Entering a Name

Enter first character (such as "N")

  and hold down

Display will show: M - N - O - 5 - M - N -

Release key when wanted character is shown.

Pressing a new key or  will cause cursor to move to next position.

Repeat the procedure for next character.

You may also select the character by pressing the  key repeatedly.

  or  To correct mistakes.

1

ESSENTIAL INFORMATION



Entering the Short-number

If you have no preference for a particular short-number,

 as the short-number.

The telephone number and name will then automatically be stored in the next available short-number location. This feature is most often used when programming short-numbers with names.

If you want the next available short-number location in a particular decade, like the fifties,

  as the short-number.

If you want a specific short-number, like 2,



Programming Examples

Example no. 1.

Short-number: Next available.

Name: Peter

Telephone no.: 1 3 5 7 9 2 4

This is what you do:



Action:

Enter Letter mode



Select P



and hold

Select E



and hold

Select T



and hold

Select E



and hold

Select R

ESSENTIAL INFORMATION

1



Leave Letter mode



Store



Next available *

* Entering **O+ O+ O+** will speed up storage.

To confirm storage the display shows, for short-number 1:

'Stored At 1'

If the memory is completely full the display shows:

'Full'

Example no. 2.

Short-number: 3.
Name: None
Telephone no.: 1 3 5 7 9 2 4



telephone number _____
store _____
short-number _____

If the selected short-number is unoccupied the display shows:

'Stored At 3'

If the selected short-number is occupied the display shows:

'3' In Use'

1

ESSENTIAL INFORMATION

Choose another short-number by:

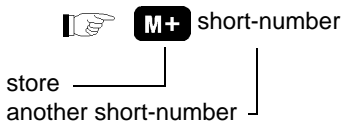

Short-number Recalling/Dialling

Short-numbers can either be recalled by name or by the short-number itself.



To recall by the short-number:

 **MR** Short-number



The name (if any), short-number and telephone number will appear in the display. When the short-number is recalled you can:

Review the recalled short-number:

 **MR** and hold

Scroll forward in short-numbers:  

Scroll backward in short-numbers:  

Call the recalled short-number:  

Exit short numbers:  

To recall by name:

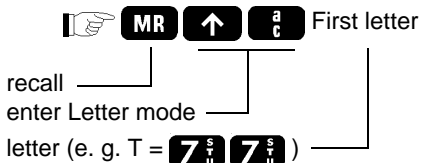

ESSENTIAL INFORMATION



1



The name, short-number and telephone number will appear in the display.



When recalled you can:

Review the recalled short-number:

 **MR** and hold

Scroll forward in alphabetic order:  



Scroll backward in alphabetic order:  

Call the recalled short-number:  

Exit short numbers:  

Speed Dialling

It is possible to dial a short-number directly from memory. This is done as follows:





 short-number 

when the call is answered lift the handset.

The called number is displayed.

Short-number Clearing

Recall the short-number. Check that it is the number you want to clear.

If OK,   (If not  )

The display then shows:

'Clear?'

Confirm by   (otherwise )

1

ESSENTIAL INFORMATION

Reviewing Phone Numbers

To review the last number entered:

 **MR** and hold.



To review a long phone number, after recalling it from memory:

 **MR** and hold.

MEMORY FEATURES**Notepad**

To store a telephone number during conversation, simply enter the number and end the conversation the usual way.

You may next call the telephone number or store it as a short-number.

Call the number by:  



Store the number by:

 **M+** short-number



Recall the number by:  **MR** and hold

Last Number Dialed

Recall the number by:  **MR** **Q+**

Call the recalled number by:  

For security reasons, you may wish to clear the last number dialed by:

 any invalid number  

2

ADVANCED INFORMATION

SYSTEM REGISTRATION

Automatic Roaming

The SIM Card memory contains space for a list of "preferred" network operators.

If coverage on your home system becomes unavailable, the telephone will automatically try to establish contact with one of the preferred network operators on this list.

This is done in the order that they are listed.

If automatic roaming is successful, the

▲ indicator will light up indicating that you are registered on a preferred system different from your home system.

If service from one of the preferred network operators is not available, the display shows:

'Select Service'

To defer service selection:



To see a list of available network operators in the area where you are located:



The display shows the first service operator on the list. Operators are listed in order of decreasing signal strength.

Scroll forward in the list:

Scroll backward in the list:

Select displayed network operator:

If you are accepted by the system, the display will show the network operator code and the ▲ indicator will start flashing indicating that you are registered on a non-preferred system.

If you are not accepted by the system, the ∅ indicator will flash.

You may then continue as described in the section, "Manual Roaming".

Manual Roaming

You may manually select a network operator from a list of those providing coverage at your immediate location.

To see the list of available network operators:



Operators are listed in order of decreasing signal strength. The display shows the first network operator as:

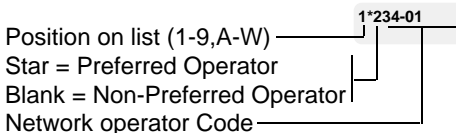

The lower line of the display may show the name of the network operator or the country abbreviation with the network number.

The procedure for scrolling/selecting is described in the section "Automatic Roaming"

2

ADVANCED INFORMATION

Preferred Network Operator List

The Preferred Network Operator List has been expanded from 9 to 32 entries. These are labelled as; 1-9, A-W.



Displaying the Preferred List



To see the list of preferred network operators:

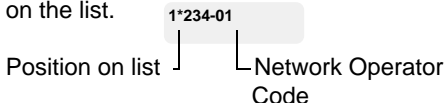

The display shows the first network operator on the list.



Scroll forward in the list:  

Scroll backward in the list:  

When network operators have not been programmed, those positions will appear empty.

To programme a network operator see the section, "Changing the Preferred List".

Changing the Preferred List

Note: A list of international network operators and their codes can be obtained from your network operator.

Enter the preferred list and scroll to the position you want to change as described in the section, "Displaying the Preferred List".

ADVANCED INFORMATION

2



To change the displayed network operator:

 **M+** Network Operator Code

Example:

Network Operator Code = 234-01

     

  to scroll to position

To clear the displayed network operator:

Check that it is the network operator you want to clear.

If OK,   (If not  )



The display then shows:

'Clear?'

Confirm by   (otherwise  )

MENU OPERATION

Menu operation allows you to select and cancel features by following the prompts in the display.

To enter menu mode:   

The features are grouped under menu headings.

Menu headings:

General Features

Entered by:

Interface Features

Call Monitor Features

Call Restriction Features

Secure Features

2

ADVANCED INFORMATION

Other Features



SMS Features



To enter a feature from menu heading:

a digit between 1 and 8 *

* See the next pages for an overview

Once the desired feature is displayed:

and follow the prompts

Many features are simply toggled on/off using the **M+** key. Some features will prompt for further information such as the security code.

To scroll in the menu headings/features:

to go forward

to go backward

To return to menu headings:



To exit menu mode:



Overview Menu Headings and Features

Key Press: **Menu heading/Feature:**

1 A B C

General Features

+ **1** A B C Status Review

+ **2** A B C D Automatic Answer

+ **3** A B C D E Manual Roaming

+ **4** A B C D E F G H I J K L Preferred List Display/Change

+ **5** A B C D E F G H I J K L M N O P Q R S T U V W X Y Z Auxiliary Alert*

Key Press: **Menu heading/Feature:**

2
DEF

Interface Features

- + **1**
ABC Ringer ON/OFF
- + **2**
DEF Keypad Tones ON/OFF
- + **3**
GHI Notepad Tones ON/OFF
- + **4**
JKL Long Tone DTMF
- + **5**
MNO PIN Code Enable/Disable
- + **6**
PQR Language Selection
- + **7**
STU Safety Timer Setting
- + **8**
VWX Light Level

3
GHI

Call Monitor Features

- + **1**
ABC 1 minute Audible Timer
- + **2**
DEF Programmable Audible Timer
- + **3**
GHI Once Only Audible Timer
- + **4**
JKL Automatic Monitor Displays
- + **5**
MNO Display Call Timers
- + **6**
PQR Display Call Meters
- + **7**
STU Rate Programming
- + **8**
VWX Timers/Meters Reset

4
JKL

Call Restriction Features

- + **1**
ABC Restrict Keypad Dialling
- + **2**
DEF Restrict Memory Access
- + **3**
GHI Restrict Incoming Calls
- + **4**
JKL Restrict Phone No. Length
- + **5**
MNO No Restrictions, Full Service

* Not displayed when used in the carrying cassette

2

ADVANCED INFORMATION

Key Press: **Menu heading/Feature:**

5 M
O
N
O

Secure Features

- + **1** A
B
C Change/Display Unlock Code
- + **2** R
E
T
U
R
N Master Reset
- + **3** C
H
I
L
D Master Clear
- + **4** J
K
L Change Security Code
- + **5** M
O
N
O Automatic Lock

6 R
O
P

Other Features

- + **1** A
B
C Battery Save Feature (DTX)**

7 S
T
S

SMS Features

- + **1** A
B
C Auto Cell Broadcast
- + **2** R
E
T
U
R
N Short Message Alert Tone ON/OFF

** Only displayed when used in the carrying cassette

Status Review

The Status Review feature allows you to review any features that have been changed from their default state.

To review the features selected:



To scroll:

to go forward

to go backward

If the display shows:

'Standard' No default settings
have been changed

To exit status review:  

Master Reset

USE THIS FEATURE WITH CAUTION

Using this feature you can reset all of the features back to their default settings.

Which means:

Cancellation of:

- Automatic Answer
- Long Tone DTMF
- Safety Timer
- All Audible Timers
- Automatic Call Monitor Display
- Battery Saving Feature (DTX)
- Selected Language (Default: English)
- Auxiliary Alert (if installed)
- Auto Cell Broadcast

Restoring of:

- Ringer
- Notepad Tones
- Light Level to High
- No restrictions on calls
- Unlocks the telephone
- Volume Levels to medium

To carry out a Master Reset:

     
Security Code

The reset is confirmed in the display by:
'Reset Complete'

2

ADVANCED INFORMATION

Master Clear

USE THIS FEATURE WITH CAUTION

Using this feature you perform the same function as Master Reset plus these additional functions:

- Clears:
- All 100 short-numbers
 - Last number called
 - Home Charge Rate
 - Roam Charge Rate
- Resets:
- Resettable Call Timers
 - Resettable Call Meters

To carry out a Master Clear:



When a Master Clear is completed the display shows:

'Clear Complete'

INTERFACE FEATURES

The interface features allow you to customize the telephone to meet your needs.

Ringer ON/OFF

To mute the ring tone of incoming calls and replace it with the word **'Call'** flashing in the display.



 **M+** to toggle the ringer on/off.

If "Automatic Answer" has been selected, muting the ring tone is not recommended.

Keypad Tones ON/OFF

To mute the tones heard when pressing keys:



 **M+** to toggle the function on/off.

Tone Signalling Features

The tone signalling features allow you to communicate with external devices that respond to Dual Tone Multi-Frequency (DTMF) tones.

Notepad Tones ON/OFF

If you use the Notepad feature often, the DTMF tones heard by the other party when you press the keys may be irritating.

To mute these tones:





 **M+** to toggle the function on/off

With the notepad tones muted, you will hear a feed back tone when you press a key, but the called party will not.

2 ADVANCED INFORMATION

If you want to transmit DTMF tones while the Notepad tones are muted, simply:

 enter the digits **MR** 

Memory Linking

Memory linking allows you to append a short-number from memory to a number already in the display.



To link numbers:

 enter digits **↑** **MR** short-number

Pauses in Memory

This feature allows you to construct and dial sequences of digits separated by pauses. A pause in the number sequence will stop the transmission at that point to allow for a system response, such as a second dial tone. An additional 12 digits may be appended to the standard length of 20 digits for a total of 32 digits. The international prefix (+) and pause character(s) (□) each represent one digit.

To construct sequences:

 enter digits **↑** 
pause —————
enter digits **↑**  etc.
pause —————



Note: If you want to recall a short-number instead of entering the digits after a pause has already been inserted:

  **MR** short-number

The sequence may be stored in short-number 1 through 100 like any ordinary telephone number.

Short-numbers above 100 (those on your SIM Card) cannot be used to store sequences containing pauses.

To make a call with a sequence:

 Construct or recall sequence 

Digits prior to pause are transmitted.

Await response (dial tone) 

Digits prior to next pause are transmitted.

Repeat until all digits have been transmitted.

DTMF Signalling

DTMF signalling is used, for example, when you want to use the public paging service. See also the section "Long Tone DTMF".



DTMF dialling from the keypad:

1. Place the call and wait for the receiving party to accept data.
2. Enter the digits you want to transmit on the keypad. Each key press transmits the digit as a DTMF tone.

Note: Do not use the  key

2 ADVANCED INFORMATION

DTMF dialling from short-number memory:

1. Place the call and wait for the receiving party to accept data.
2. Recall the desired short-number.
3.   

Repeat 2 and 3, if necessary, until all data have been transmitted.

Long Tone DTMF

Some electronic equipment such as answering machines may require longer tones. By enabling the long tone DTMF feature the DTMF tone is transmitted as long as you press the key.

To enable/disable long tone DTMF:



  to toggle the function on/off.

PIN Code Enable/Disable

You may enable/disable the PIN Code if your SIM Card allows it.

When disabled you do not have to enter the PIN Code when the telephone is turned on.

To enable/disable the PIN Code:



PIN Code 

The display may show:

'Not Allowed': Disabling the PIN Code is not allowed by the network operator.

'Wrong PIN': The PIN Code was wrong and you must start all over.

'Blocked': Three unsuccessful attempts of entering the PIN Code have been carried out. See the section, "UNBLOCKING THE SIM CARD".

Language Selection



Using this feature it is possible to select the language in which the prompts are to be displayed.



To select language:



Scroll to preferred language:

  to go forward

  to go backward

  to confirm the selection.

Safety Timer

The safety timer allows the phone to remain on for a specified period of time after the vehicle's ignition has been turned off. To prevent draining the vehicle's battery, the safety timer will turn the phone off after the time period has expired. If you are in a call when the timer expires, the phone will power down after the call is completed. This feature prevents the user from having to re-enter the electronic unlock code and the PIN number for the SIM card every time the vehicle's ignition is turned off. At the time of purchase, the timer is set for one hour. You can, how-

2 ADVANCED INFORMATION

ever, adjust the length of the safety timer from zero (0) minutes to 999 minutes. When set for zero (0) minutes, this feature is effectively disabled and the phone powers off with the ignition. If, however, you switch the phone on again whilst the ignition remains off, the safety timer will reset to one hour.

To change the length of time of the safety timer from 1 hour, select the safety timer feature:



The display shows the present time period.

To change the time period:

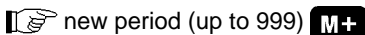

Entertainment Mute

If your installation supports the Entertainment Mute feature, the vehicle's stereo will mute when a call is made or received. Entertainment Mute is activated when your mobile phone is installed. With this feature enabled, it is not possible to have Auxiliary Alert.

Auxiliary Alert

If your installation supports auxiliary alert and the function is enabled, an incoming call will activate an external alerting device (horn/light).

To enable/disable:



 **M+** to toggle the function on/off

Note: Auxiliary Alert will remain on, even if the vehicle's ignition is off, until the Safety Timer expires.

The display will show: **'Alert'**

This feature is not available on all phones. With this feature activated, it is not possible to have Entertainment Mute. Please note that it is illegal, in some countries, to utilize Auxiliary Alert.

Adjust Light Level

You may adjust the intensity of the display and keypad backlighting to one of four levels: Off - Low - Medium - High

To select light level



Display reads the present level.

 **M+** consecutively to change the selection.

CALL MONITORING

The telephone has a variety of features to help you monitor time and cost of calls. Two types of call monitoring features are available: audible and visual. They may be active concurrently.

Note: Depending upon your model, the phone will monitor either all calls or only outgoing calls.

2

ADVANCED INFORMATION

One Minute Audible Call Timer

A beep is heard 10 seconds before the end of each minute of a call.

To enable/disable:



M+ to toggle the function on/off.

Programmable Audible Call Timer

A beep is heard 10 seconds before **each** expiration of a time period (Up to 999 seconds), which you may programme.

To enable/disable:



time period in seconds **M+**

M+ to toggle the function on/off.

One Time - Programmable Audible Call Timer

A beep is heard 10 seconds before the **first** expiration of a time period (Up to 999 seconds) which you may programme.

To enable/disable:



time period in seconds **M+**

M+ to toggle the function on/off.

Visual Call Timers and Meters

The visual call monitors consist of seven call timers and seven call meters (see Note, CALL MONITORING). To utilize the seven call meters you must programme a rate-per-minute into your phone, using charge units or currency. Three types of timers and meters are available.

Individual call timers/meters:

Shows call time and charge for the most recently made call. They are automatically reset before each call.

To see time/charge for a call see the section, "Automatic Monitor Displays".

Resettable call timers/meters:

Shows call time and charge for the period since you last reset the timers.

You will find the following resettable call timers/meters in the telephone:

Home: Shows time and charge for home system since last reset.

Roam: Shows time and charge for other systems since last reset.

Total: Shows the sum of Home and Roam.

To reset all resettable call timers/meters:

2

ADVANCED INFORMATION

Cumulative call timers/meters:

Shows the total time and charge for the life of the telephone.

You will find the following cumulative call timers/meters in the telephone:

Home: Shows time and charge for home system since the telephone was put into service.

Roam: Shows time and charge for other systems since the telephone was put into service.

Total: Shows the sum of Home and Roam.

To Display Call Timers



Select by scrolling to the desired timer in the list of call timers:

- Individual Call Timer
- Total Resettable Call Timer
- Home Resettable Call Timer
- Roam Resettable Call Timer
- Total Cumulative Call Timer
- Home Cumulative Call Timer
- Roam Cumulative Call Timer



to go forward



to go backward

To Display Call Meters

Displaying meters requires that the telephone is programmed with a home and roam rate. See the section, "Programming of Rates".



Select by scrolling to the desired meter in the list of call meters:

- Individual Call Meter
- Total Resettable Call Meter
- Home Resettable Call Meter
- Roam Resettable Call Meter
- Total Cumulative Call Meter
- Home Cumulative Call Meter
- Roam Cumulative Call Meter

to go forward

to go backward

Programming of Rates

To display call meters, the home and the roam rate must be programmed. The rates can be entered in either currency per minute or charge units per minute.

To programme the rates:



Security Code

Home Rate Roam Rate

Note: The roam rate initially defaults to the home rate to prevent you from setting it to zero by mistake.

2

ADVANCED INFORMATION

Automatic Monitor Displays

This feature can be used to automatically display the time or charge for a call during and after each call (see Note, CALL MONITORING).

To enable/disable:



Select auto timer or auto meter using the scroll keys.

 **M+** to confirm the selection.

 **M+** to toggle the function on/off.

CALL RESTRICTIONS

Call restriction settings are stored in the telephone, but may affect usage of the SIM card.

Four types of restrictions are available:

- Restricted Keypad Dialling
- Restricted Memory Access
- Restricted Incoming Calls
- Restricted Phone Number Length

They may be enabled/disabled independently to suit your needs.

Restricted Keypad Dialling

Prevents any keypad dialling except for "112" emergency dialling. Short-numbers, which have not been prohibited by the Restricted Memory Access feature, may be called but not programmed.

To enable/disable:



To toggle the function on/off:



Restricted Memory Access

With restricted memory access you select a range of short-numbers which should always be accessible for storing and recalling.

For the short-numbers outside the range you have the following alternatives:

Protect: Storing and recalling are not allowed

Recall Only: Only recalling is allowed.

To enable/disable:



M+ Security Code

Select "protect" or "recall only" using the scroll keys and then **M+**

Lower limit **M+** Higher limit **M+**

2

ADVANCED INFORMATION

Restricted Incoming Calls

Only outgoing calls are allowed.

To enable/disable:



To toggle the function on/off:

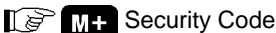

Restricted Phone Number Length

Among other uses, this feature can be used to prevent international calls. Only phone numbers less than or equal to the selected maximum number of digits may be called.

To enable/disable:



M+ Security Code

Display shows present maximum

To enter new maximum:

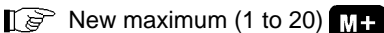

Note: DTMF signalling is disabled.

"112" emergency calls are still possible.

Digits after pauses in telephone numbers do not count towards length limit.

Full Service

Use of this feature removes all restrictions previously selected.



M+ Security Code

CALL BARRING

Call barring applies only to the SIM Card, not the telephone.

By subscribing to call barring, you may bar incoming and/or outgoing calls by entering a special key sequence. The key sequence includes a "barring code" indicating which calls should be barred and a password.

The first password is provided by the network operator when you subscribe to the service.

The most common types of call barring are:

All outgoing calls **Barring code: 33**

Note: If barring of all outgoing calls is activated, activating other types of outgoing call barring will not make sense.

All outgoing international calls **Barring code: 331**

All outgoing international calls except those to home network operator **Barring code: 332**

All incoming calls **Barring code: 35**

Note: If barring all incoming calls is activated, activating other types of incoming call barring will not make sense.

2

ADVANCED INFORMATION

All incoming calls when roaming

Barring code: 351

Additional call barring services may be provided. Consult your network operator for further information.

Call barring of all incoming calls is used in the following examples. For other types of call barring replace the barring code with the appropriate code for the type in question.

Activating Call Barring



Possible display messages:

'Please Wait': Your request is being processed.

'Barring On': Barring has been enabled.

Example:



Barring: All incoming calls (code: 35)

Password: 2468



Cancelling Call Barring

To cancel a single type of call barring:

  Barring code 
 Password  

To cancel all types of call barring:

     
 Password  

Display message:

'Barring Off': Barring has been disabled.

Status of Call Barring

If you have forgotten whether call barring has been activated you can check the status of the different types of call barring.

   Barring code  

Possible display messages:

'Barring On': Call barring activated.

'Barring Off': Call barring not activated.

Example:

Check: Barring all incoming calls (code: 35)

2

ADVANCED INFORMATION

Changing Call Barring Password



Possible Display messages:

'Password Changed': Password changing was successful.

'Matching Error': The two entries of the new passwords did not match. Try again.

Special Call Barring Messages

One or more of the following messages may appear when operating call barring. Additional special messages are described in the section "Special Call Forward Messages".

'Outgoing Call Barred': You have tried to make a call with barring of outgoing calls enabled.

'Wrong Password': Wrong barring password entered. Try again.

'Call Barred': The number you dialled has barred incoming calls.

CALL FORWARDING

Call forwarding applies only to the SIM Card, not the telephone. By subscribing to call forwarding, you may forward incoming calls to another telephone number by entering a special key sequence. The key sequence includes a "forwarding code" indicating when an incoming call should be forwarded.

The most common types of call forwarding :***Unconditionally* Forwarding code: 21**

Forwards all incoming calls.

Note: If Unconditional call forwarding is activated, activating other types of call forwarding will not make sense.

***No answer* Forwarding code: 61**

Forwards calls which you do not answer.

***Not reachable* Forwarding code: 62**

Forwards calls which you cannot answer.

For example:

- if your telephone is out of coverage,
- if your telephone is switched off
- if your SIM Card is not inserted

***Busy* Forwarding code: 67**

Forwards calls received while your phone number is busy.

Additional call forwarding services may be provided. Consult your network operator for further information.

Call forwarding "on busy" is used in the following examples. For other types of call forwarding replace the forwarding code with the appropriate code for the type in question.

2

ADVANCED INFORMATION

Activating Call Forwarding



Possible display messages:

'Please Wait': Your request is being processed.

'Forward On': Activation was successful. Also displayed each time you place a call if call forwarding is enabled.

'Invalid Number': The telephone number entered to receive the call is invalid.

Note: You may use different phone numbers for different types of call forwarding.

Example:

When: Forwarding, if busy (code: 67)
Telephone no. to receive call: 13579246

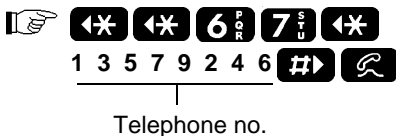

Cancelling Call Forwarding

To cancel a single type of call forwarding:

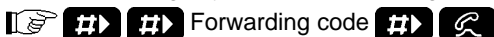

ADVANCED INFORMATION

2

To cancel all types of call forwarding:



Display message:

'Forward Off': Cancellation was successful.
Also displayed if the network cancels the call forwarding.

Example:

Cancellation of: Forwarding, if busy (code: 67)



Status of Call Forwarding

If you have forgotten whether call forwarding is active or to which phone number calls are being forwarded, you can check the status of the different types of call forwarding.

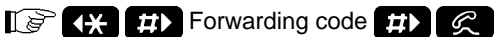

Possible display messages:

'Forward On 13579246': Call forwarding activated to the shown phone number.

'Forward Off': Call forwarding not activated.

Example:

Check: Call forwarding, if busy (code: 67)



2

ADVANCED INFORMATION

Special Call Forwarding Messages

One or more of the following messages may appear when using call forwarding.

'Call Forward': A call placed to you has been forwarded or a phone number you have called has been forwarded.

'Busy Try Later': The network is currently processing your earlier request. Try again later.

'Not Allowed': You cannot activate this service. Possible reasons: Service subscription problems. Incompatible service(s) activated, e.g. Call barring for incoming calls prohibits call forwarding.

'Network Problem': Communication with the network failed. Try again.

'Invalid Command': Failure in key sequence. Try again. May also indicate that the attempt was unsuccessful. If the message appears after repeated attempts consult your network operator.

'Not Available': This service is not available.

CHANGING THE UNLOCK CODE

To change the Unlock Code:



Security Code

Display shows current Unlock Code



New Unlock Code (3 or 4 digit)



CHANGING THE SECURITY CODE

Upon delivery, your security code is "000000".

To change the security code:

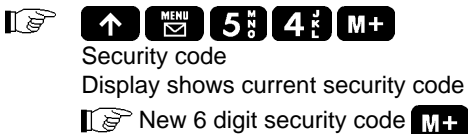

Write the new security code on your Telephone Data card. If you do not know the programmed security code, contact your telephone dealer's service centre.

CHANGING THE PIN CODE

The first PIN Code is selected by the SIM card provider. The PIN Code must be enabled before it can be changed.

To change the PIN Code:

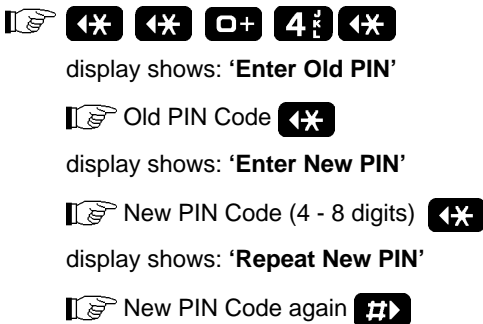

If the display shows:

'OK': The PIN Code has been changed.

2

ADVANCED INFORMATION

'Matching Error': The two new PIN codes did not match and you must start all over.

'Wrong PIN': Your old PIN Code was wrong and you must start all over.

If you do not succeed after three attempts the SIM card is blocked. See the section: "Unblocking the SIM Card".

Note: If you have forgotten your old PIN Code you may choose a new PIN Code by using the procedure described in the section, "UNBLOCKING THE SIM CARD".

UNBLOCKING THE SIM CARD

The SIM card is blocked from use when three unsuccessful attempts to enter the PIN Code have been carried out.

To unblock the SIM card again you must choose a new PIN Code by the following the procedure described below. Use the Unblock Code supplied by the SIM card provider.

To unblock the SIM Card:

When display shows: **'Blocked'**



display shows:



'Enter Unblock Code'

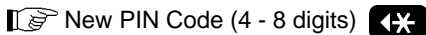

display shows: **'Enter New PIN'**



display shows: **'Repeat New PIN'**

 New PIN Code again 

If the display then shows:

'OK': You have unblocked the SIM card and entered a new PIN Code.

If the display shows:

'Matching Error Blocked': The two new PIN codes did not match and you must start all over.

'Wrong Code Blocked': Your unblock code was wrong and you must start all over.

If you do not succeed after ten attempts the SIM card is permanently blocked. The display shows:

'Blocked See Supplier'

You must then seek help from your network operator.

2

ADVANCED INFORMATION

SHORT MESSAGE SERVICE (SMS)

The Short Message Service (SMS) is comprised of a set of features which enables your GSM phone to send and receive messages to and from the network. This model phone is designed to support both the Cell Broadcast and Point to Point Mobile Terminated portions of the SMS feature set.

Automatic Cell Broadcast

Your Network Operator may wish to send you important messages using a GSM feature called 'Cell Broadcast.' The Network Operator sends the information to your phone over a 'broadcast channel' (similar to television or entertainment radio transmissions. This channel may also be referred to as a 'Message Identifier' by some publications). By selecting 'Auto Cell Broadcast' and entering the appropriate broadcast channel number, these messages will scroll across your phone's display whenever you are not in a call.

There may be multiple broadcast channels in your service area. Please contact your Network Operator for a list of available channels and the information they supply.

To select:



a c can be used to correct undesired channel number entries)

ADVANCED INFORMATION

2

The phone will display the selected channel for a few seconds and then revert back to the ON/OFF menu heading.

To select/cancel:



 **M+** to toggle feature on/off

To change broadcast channel:

First ensure that the feature is turned off, using the cancel sequence as shown above.

Then:



new cell broadcast channel **M+**

To exit Cell Broadcast menu:



To scroll through complete message (when not in a call):



2

ADVANCED INFORMATION



Point to Point Short Messages

Your phone can also receive Point to Point Short Messages. These messages are not the same as the Cell Broadcast messages, as they are transmitted to your phone only. The received messages are stored on your SIM card and they can be retrieved at a later date.

Receiving Point to Point Messages

When your phone receives a message, it will follow the procedure below.

1. There will be an alert signal of three short tones.
2. The Short Message Service icon will light.
3. The display will show **'Message'** if the phone is not in a call.
4. The message will be stored in the SIM card. Up to a maximum of 35 messages may be stored this way. The maximum number of messages stored will also depend upon the SIM card, since some SIM cards will have a lower capacity.

If the display shows **'Message'**, when you are using the feature menu, pressing the  key will return you to the feature menu, but pressing  will display the new message.

Storage of Point to Point Messages

When a message is received, the phone will check to see if there is a location available, for storing the message, in the SIM card.

If the SIM card is full then the  icon will flash. No more messages can be stored in the SIM card, until one or more of the stored messages are removed.

The new messages may be saved by your Network Operator and sent, at a later date, when a location becomes available in the SIM card. If a message location is not made available within a set time period, the Network Operator may remove the new messages.

Reading Point to Point Messages

Pressing the  key will show the number of messages you have at present. The top line shows the number of new messages and the bottom line indicates the number of older messages. This display will go out after two seconds.

Up to 35 messages can be stored, depending upon the SIM card capacity. These messages will be identified by a number between 1 and 35. The oldest unread message will be in location 1.

The bottom line of the display will display the message. The message will automatically scroll twice from right to left.

2

ADVANCED INFORMATION

To stop the message scrolling:



To start the message scrolling again:



To view other messages:



To delete the message:



The next message will be displayed, if there is one, or the menu will exit if there are no further messages.

All messages have the date, time and caller's phone number printed at the end in the following format: <Day/Month/Time> <Caller's phone number>.

Note the availability of the caller's phone number is controlled by the Network Operator.

Clearing Messages From Memory

To remove a message from memory:



The phone will show the following message - **'Clear?'**

To confirm the deletion:



or



When a message has been deleted the next message will be displayed, if there is one. If there are no further messages the menu will be exited.

Embedded Callback Numbers

If a phone number is included in the message, within quotation marks, the phone has the ability to call the number by simply pressing the  key.

For example the following message would permit the callback feature.

Phone "MCSG" on "0555 444 333" by 12:00

The first section within quotation marks would be ignored, because it does not start with a number.

Be warned, however, in the event of receiving the following message:

Phone "1st National" on "0555 666 777"

The callback feature would attempt to call 1!

If there is no phone number in quotation marks, then the callback feature will call the <caller's phone numbr> at the end of the message, if it is supported by the Network Operator

Short Message Alert Tone

You have the option to turn the Short Message Alert Tone on or off.

To turn the alert tone on or off:



 **M+** to toggle feature on/off.

2

ADVANCED INFORMATION

CALL WAITING AND CALL HOLDING

This model phone supports the GSM 'Call Hold' and 'Call Waiting' features. In order to use these features the following conditions must be met. Firstly, the Network Operator has made the feature available and secondly, you have subscribed to the feature. Using these features you may place a current call on hold and either accept an incoming call or start a second call.

Call Waiting

You have the option to turn the call waiting feature on or off, for future calls.

To turn call waiting on:



The display will show 'Call Waiting On' if the activation is successful.

To turn call waiting off:



The display will show 'Call Waiting Off' if the deactivation is successful.

To check call waiting status:



The display will show 'Call Waiting On' or 'Call Waiting Off'.

When the Call Waiting feature is on and a call is in progress, a second caller to your phone will hear the ring tone. Your phone will produce a single beep, followed by a double beep every eight seconds and the display will show '**Call Waiting**'.

If however the feature is off, a second caller will hear the busy tone.

Call Holding

This feature is controlled by your Network Operator and is used in conjunction with the call waiting feature to produce several different results.

Call Hold and Waiting Combinations

If a call is active and there is no call waiting:



The active call will be placed on hold and the display will show '**Holding**' to indicate that the hold request is in progress. The display will show '**Call Holding**' when the process is complete.

or



The active call will end and the phone will be available for further calls.

2

ADVANCED INFORMATION

If a call is active and there is a call waiting:



The active call will be placed on hold and the display will show '**Holding**' to indicate that the hold request is in progress. When the call has been held, the display will show '**Accepting**' to show that the waiting call is being connected. '**Call Holding**' will be shown when the process is complete.

or



The display will show '**Please Wait**' while the active call is ending. When the call has been ended, the display will show '**Accepting**' to show that the waiting call is being connected.

If a call is active and there is a held call:



The display will show '**Switching**' as the held call becomes active and the previously active call is held. '**Call Holding**' will be shown when the process is complete.

or



The active call will end and the currently held call will become active.

If a call is held and there is no call waiting:



The display will change from '**Call Holding**' to '**Connecting**' as the held call becomes active.

or



The held call will end and the phone will be available for further calls.

If a call is held and there is a call waiting:



The display will show '**Accepting**' to show that the waiting call is being connected. The currently held call will remain held and '**Call Holding**' will be shown when the process is complete.

or



The display will show '**Please Wait**' while the held call ends. When the call has been ended, the display will show '**Accepting**' to show that the waiting call is being connected.

2

ADVANCED INFORMATION

Call Hold and Making New calls

If a call is active and there is no call waiting:

Place the call on hold as described above and then:



Telephone number 

The '**Dialling**' message will be shown, to indicate that the new call is being attempted. The display will show '**Call Holding**' when the process is complete.

Call Hold and Call Waiting Messages

There are several messages which may appear during call hold and call waiting operations.

'Hold Fail': an active call could not be put on hold.

'Connect Fail': a held call could not be made active again.

'Answer Waiting Call': an attempt to make a new call was made whilst a call is waiting. The waiting call must be answered first.

'Cannot Hold Second Call': a call is already on hold, you cannot place two calls on hold at the same time.

'Busy Try Later': the phone is still working on a previous command. Wait for a short time before repeating the command.

Emergency Calls and Call Hold/Wait

If you make a call to the GSM emergency number, then any currently active, held or waiting calls will end.

You cannot use the hold or waiting features when you are making an emergency call.

2

ADVANCED INFORMATION

CARRYING CASSETTE**Overview**

See figures on rear cover.

Note: Fig 2 B means "arrow B in figure 2".

- fig. 1 A) Release button
B) Power connector
C) Antenna connector
- fig. 2 A) Antenna connector
B) Cutaway
C) Transceiver latch
D) Power connector
- fig. 3 A) Handset connector
B) Antenna
C) Shoulder strap clip
D) Battery
E) Battery latch

Removal from the Vehicle

Handset: Always start by making sure that the telephone is switched off. Lift the handset from its mount. Press the lock on the coil cord plug while pulling it out. You are now ready to remove the transceiver.

Transceiver: Disconnect the power cable (fig. 1 B) and the antenna cable (fig. 1 C). Press release button (fig. 1 A) while sliding the transceiver toward tray's back wall. Lift the transceiver from the tray.

3

ACCESSORIES AND OPTIONS

Insertion into the carrying cassette

Lower the transceiver into the carrying cassette as shown in fig. 2. The antenna connector (fig. 2 A) will fit into the cutaway (fig. 2 B). Slide the transceiver forward until a click is heard indicating that the unit is locked into place. Connect the handset coil cord to the handset connector (fig. 3 A). Place the handset in the mount. Mount the antenna (fig. 3 B) on the rotating antenna socket. Attach the shoulder strap by sliding the clips (fig. 3 C) into the slots in the carrying cassette. The clips will lock into place. To remove the shoulder strap, press the tabs and lift the clips

To Insert the Battery

Slide the battery (fig. 3 D) into the compartment until it locks into place. Arrows on the battery indicate the end to insert first. The + sign on the battery should be facing up.

To Remove the Battery

Pull the battery latch up (fig. 3 E). The battery will automatically slide out for easy removal.

Battery Charging

The carrying cassette uses a rechargeable lead-acid battery. The life of a battery can be greatly affected by the charging method as well as the use.

To maximise battery life:

- Charge new batteries before use
- Avoid discharging the battery completely.
- Charge after extensive use.
- Turn the telephone off while charging
- Charge at or near room temperature
- Avoid overcharging
- Store batteries fully charged

Overnight Charger

Connect the charger to the power connector (fig. 2 D) on the carrying cassette. Plug the charger into the wall outlet.

The overnight charger will take approximately 8 hours to charge a completely discharged battery with the telephone switched off.

Spare Battery Charger

Remove the battery from the carrying cassette. Connect the cable to the battery contacts. Plug the charger into the wall outlet. The Spare Battery Charger will take approximately 4 hours to charge a completely discharged battery.

Cigarette Lighter Adaptor

The Cigarette Lighter Adaptor supplies power to the carrying cassette from the vehicle's electrical system. For this reason it is advisable to use the adaptor only when the engine is running.

Connect the cable to the power connector (fig. 2 D) on the carrying cassette. Plug the Adaptor into the cigarette lighter.

Depending on your vehicle's electrical system and usage of the phone, your battery may charge or discharge while using this adaptor. The adaptor has a 10 Amp fuse which you may replace yourself, if necessary.

Mains Operation - Rapid Charging

For fixed applications an alternative power source to the battery is the main power supply. Connect the power supply to the power connector (fig. 2 D) on the carrying cassette. Plug the power supply into the wall outlet.

3

ACCESSORIES AND OPTIONS

You may either remove the battery or leave it in. If you leave it in, a completely discharged battery will be fully charged in approximately four hours.

Operation in the Carrying Cassette

Keypad and Display Lighting

To conserve battery power, the keypad and display lighting will turn off after a few seconds. Pressing any key will turn the lighting back on.

Hands Free Operation

Hands Free operation may also be used when the telephone is placed in the carrying cassette. The operation is carried out as described elsewhere in this user guide. When operating in Hands Free mode, you will hear the call through the loudspeaker built into the carrying Cassette. Direct your conversation towards the microphone built into the handle.

Low Battery Indicator

The Battery Level Meter on the display indicates the level of the battery.

When the battery needs to be charged a warning tone is heard and the display shows:

'Low Battery'

When the battery strength drops below the lowest level for normal function, the telephone is switched off automatically.

Note: If powered via the Cigarette Lighter Adapter, the display will not show the battery strength indicator, since the transportable is powered from the vehicle's battery.

Battery Saving Feature (DTX)

The Battery Saving Feature, also known as Discontinuous Transmission, allows the telephone to operate at reduced power when conversation is not taking place.

To enable/disable the DTX feature:



  to toggle the feature on/off

The menu for this feature only appears when the phone is used in the Carrying Cassette.

Use Inside a Vehicle

With vehicle installation. Remove the handset and transceiver from the carrying cassette and reinstall in the vehicle. To remove, reverse the earlier instruction for assembly. To remove transceiver - release transceiver latch (fig. 2 c).

Without vehicle installation. Secure the telephone by firmly attaching the seat belt through the carrying cassette's handle. The cigarette lighter adaptor will supply power from the vehicle's electrical system, saving the carrying cassette battery for use away from the vehicle.

To provide better reception during in-vehicle use, remove the carrying cassette antenna and connect the cable from an external antenna to the antenna connector.

3

ACCESSORIES AND OPTIONS

REMOTE CARD READER

The Remote Card Reader, typically mounted in the passenger compartment, offers maximized convenience for those who frequently use different SIM cards in their phone, or who use a single SIM card in another phone in addition to their mobile.

Your GSM SIM card can be inserted into either your transceiver or the optional Remote Card Reader. Line up the triangle mark on the SIM card with the triangle on the device being used, then push the SIM card in as far as it will go.

When SIM cards are loaded into both the transceiver and the Remote Card Reader, your GSM phone will only recognise the SIM in the Remote Card Reader. (The SIM card in the transceiver will be ignored). If you later remove either SIM card, the other will take over control of the phone.

INDEX

A

Automatic Answer	18
Automatic Cell Broadcast	62
Automatic Redial	19
Automatic Roaming	28
Auxiliary Alert	42

B

Barring password. <i>See</i> Data card	
Battery Level	8
Battery Saving Feature. <i>See</i> DTX	
Billing	7

C

Call Barring	51–54
activating	52
cancelling	53
changing password	54
special messages	54
status of	53
Call Forwarding	55–58
activating	56
cancelling	56
special messages	58
status of	57
Call Meters	46
displaying	47
Call Monitoring	43
Call Restrictions	48–50
Call Timers	46
displaying	46
Call Waiting and Call Holding	68
Call Holding.....	69
Call Hold and Call Waiting Messages	72
Call Hold and Making New calls	72
Call Hold and Waiting Combinations	69
Call Waiting	68

INDEX

Carrying Cassette. See figures on rear flap	
Carrying cassette	
battery charging	76
cigaret lighter adaptor	77
insertion and removal of battery	76
insertion of transceiver	76
mains operation	77
overnight charger	77
power saving feature (DTX)	79
removal from the vehicle	75
spare battery charger	77
use inside a vehicle	79
Charge for outgoing call	47
automatic display of charge	48
Clearing Messages From Memory	66
D	
Display	7
lighting, carrying cassette	78
lighting, vehicle	10
adjustment of light level	43
Display Call Timers and Meters	45
Display language	41
DTMF Signalling	39
DTMF tones	37
long	40
on/off. See Silent Notepad	
DTX. See Power Saving Feature	
E	
Electronic Lock	
to lock	15
to unlock	15
Embedded Callback Numbers	67
Emergency Calls and Call Hold/Wait	73
Emergency Calls	20
GSM emergency number	20
local emergency number	20

INDEX

Entering a Name	21
Entering the Short-number	22
Entertainment Mute	42
H	
Handset. <i>See</i> figure on front flap	
Handsfree	17
carrying cassette	78
incoming calls	17
outgoing calls	17
switching to handset	18
I	
Indicators	7
International Calls	19
K	
Keypad	10
adjustment of light level	43
lighting, carrying cassette	78
lighting, vehicle	10
L	
Language	41
Light level adjustment	43
Long Tone DTMF	40
Low Battery Indicator	78
M	
Manual Roaming	29
selecting a service provider	29
Master Clear	36
Master Reset	35
Memory Linking	38
Menu Operation	31
Menu Overview	32
Microphone on/off. <i>See</i> Mute	
Mute	11

INDEX

N

Notepad	27
tones on/off	37

O

One Minute Audible Call Timer	44
One Time - Programmable Audible Call Timer	44

P

Pauses in Memory	38
PIN Code	14,40
actual code. <i>See</i> Data card	
enable/disable	40
entering	14
not accepted	14
Placing a Call	16
Point to Point Short Messages	64
Preferred List of Service Providers	30
changing	30
clearing a service provider	30
Preferred Network Operator List	30

R

Rapid Charging	77
Rates, programming	47
Reading Point to Point Messages	65
Receiving a Call	16
Receiving Point to Point Messages	64
Reviewing Phone Numbers	26

S

Safety Timer	41
Security code. <i>See</i> Data card	
Short Message Alert Tone	67
Short Message Service	11
Short Message Service (SMS)	62
Short-numbers	20

INDEX

clearing	25,36
programming a name and number ...	21,22
programming a number without	
a name	21,23
recall by name	24
recall by short-number	24
Silent Keypad	37
Silent Ringer	36
SIM Card	12
inserting	12
problems with	13
unlocking	60
Speed Dialling	25
Status Review	34
Storage of Point to Point Messages	65
Switching to Hands Free operation	18
T	
Time for outgoing call	48
automatic display of time	48
Tone Signalling Features	37
U	
Unlocking code. See Data card	
Unlock Code	
actual code. See Data card	
changing	58

Fig. 1

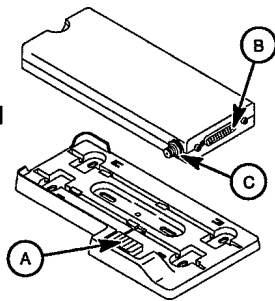

Fig. 2

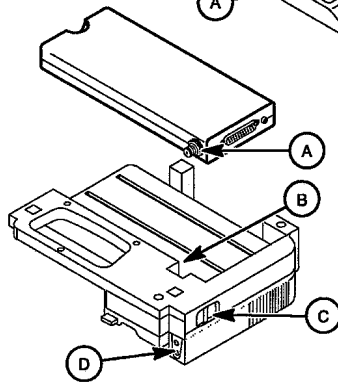

Fig. 3

